

NOTE:
Pil Tercihi
gerçekleştirildikten sonra
header, ilgili konnektör ile
değiştirilecektir.

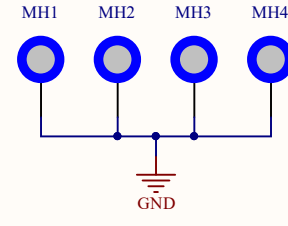

LTE-UCG-401 868 MHz - RF Anten
Sma 90C Dişi Konnektör

NOTE:
ANTEN VE SMA KONN
ALINIP, BASKIDAN ÖNCE
KILIFLAR KONTROL
EDİLMELİ. DIŞI ERKEK
BAĞLANTIYA DİKKAT
EDİLMELİ.

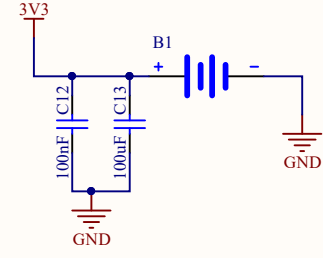
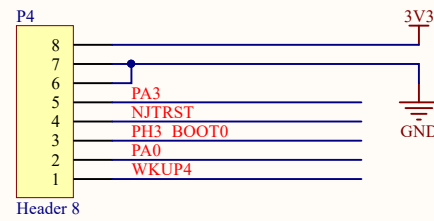
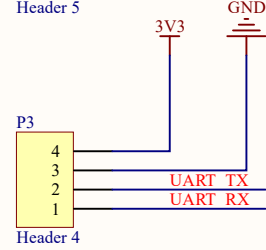
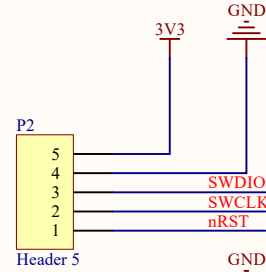
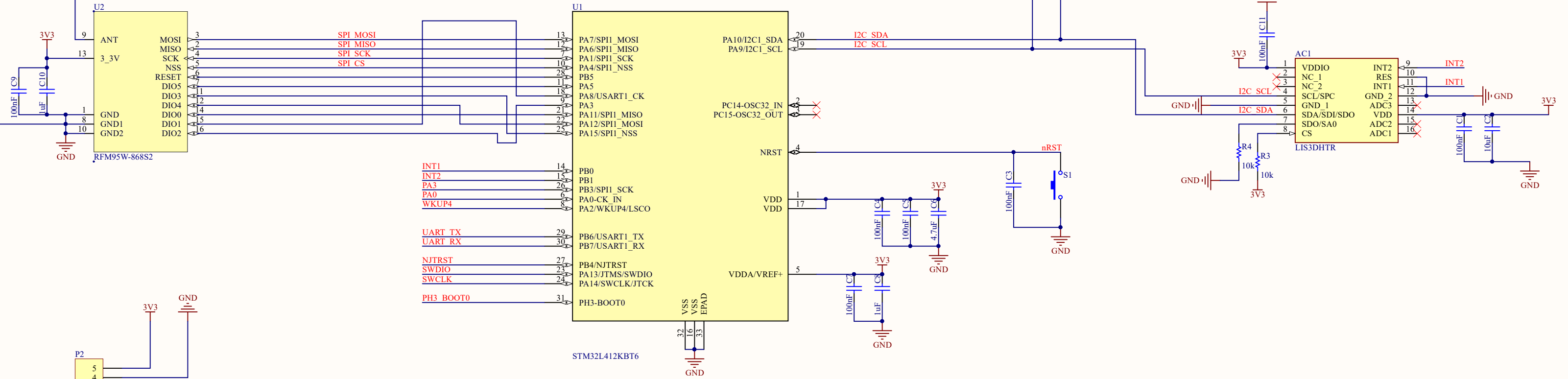
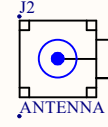

Title: Hayvancılık IC

Size: A3 Company: GMC Teknoloji

Sheet 1 of 1 Author: Mertkan Tuna